

LI-200R Pyranometer

Instruction Manual



LI-COR®

LI-200R Pyranometer

Instruction Manual

Global Headquarters

LI-COR Biosciences
4647 Superior Street
Lincoln, Nebraska 68504
Phone: +1-402-467-3576
Toll free: 800-447-3576
Fax: +1-402-467-2819
envsales@licor.com
envsupport@licor.com
www.licor.com/env

LI-COR Distributor Network:
www.licor.com/env/distributors

Regional Offices

LI-COR GmbH, Germany
Serving Andorra, Albania, Cyprus, Estonia, France, Germany, Iceland, Latvia, Lithuania, Liechtenstein, Malta, Moldova, Monaco, San Marino, Ukraine, and Vatican City.
LI-COR Biosciences GmbH
Siemensstrasse 25A
61352 Bad Homburg
Germany
Phone: +49 (0) 6172 17 17 771
Fax: +49 (0) 6172 17 17 799
envsales-gmbh@licor.com
envsupport-gmbh@licor.com

LI-COR Ltd., United Kingdom
Serving Denmark, Finland, Ireland, Norway, Sweden, and UK.
LI-COR Biosciences UK Ltd.
St. John's Innovation Centre
Cowley Road
Cambridge
CB4 0WS
United Kingdom
Phone: +44 (0) 1223 422102
Fax: +44 (0) 1223 422105
envsales-UK@licor.com
envsupport-UK@licor.com

LI-COR[®]

NOTICE

The information contained in this document is subject to change without notice.

LI-COR® MAKES NO WARRANTY OF ANY KIND WITH REGARD TO THIS MATERIAL, INCLUDING, BUT NOT LIMITED TO THE IMPLIED WARRANTIES OF MERCHANTABILITY AND FITNESS FOR A PARTICULAR PURPOSE. LI-COR shall not be liable for errors contained herein or for incidental or consequential damages in connection with the furnishing, performance, or use of this material.

This document contains proprietary information which is protected by copyright. All rights are reserved. No part of this document may be reproduced or translated into another language with prior written consent of LI-COR, Inc.

All other trademarks or registered trademarks are property of their respective owners.

© Copyright 2015, LI-COR, Inc.

CE Marking:

This product is a CE-marked product. For conformity information, contact LI-COR Support at envsupport@licor.com. Outside of the U.S., contact your local sales office or distributor.

This device complies with part 15 of the FCC Rules. Operation is subject to the following two conditions: (1) This device may not cause harmful interference, and (2) this device must accept any interference received, including interference that may cause undesired operation.

Printing History

Publication Number: 984-15210

New editions of this manual will include all updates. An update addendum may be used between editions to provide up-to-date information. Revisions are indicated by the revision number. Minor updates, which do not alter the meaning of the content, will be incorporated without affecting the revision number.

Version Number	Publication Date	Changes
1	April 2015	First Edition
2	May 2015	Second Edition; Edited Troubleshooting section.
3	July 2015	Added specifications for operating temperature and relative humidity range; Updated sensitivity specification.
4	November 2015	Removed specification for relative humidity range. Corrected wire positioning in the photo that shows how to connect a sensor to the 2420-BL Light Sensor Amplifier.

Build Date: Friday, December 09, 2016

LI-200R-BL-x; LI-200R-BNC-x (x = 2, 5, 15, 50)						
Component Name	Hazardous Substances or Elements					
	Lead (Pb)	Mercury (Hg)	Cadmium (Cd)	Chromium VI Compounds (Cr ⁶⁺)	Polybrominated Biphenyls (PBB)	Polybrominated Diphenyl Ethers (PBDE)
Pyranometer Sensor Head Assembly	X	O	O	O	O	O
Base and Cable Assembly	X	O	O	O	O	O
O: this component does not contain this hazardous substance above the maximum concentration values in homogeneous materials specified in the SJ/T 11363-2006 Industry Standard.						
X: this component does contain this hazardous substance above the maximum concentration values in homogeneous materials specified in the SJ/T 11363-2006 Industry Standard (Company can explain the technical reasons for the "X")						
LI-200R-BL-x; LI-200R-BNC-x (x = 2, 5, 15, 50)						
部件名称	有毒有害物质或元素					
	铅 (Pb)	汞 (Hg)	镉 (Cd)	六价铬 (Cr ⁶⁺)	多溴联苯 (PBB)	多溴二苯醚 (PBDE)
日照强度计传感器头组件	X	O	O	O	O	O
底座和电缆组件	X	O	O	O	O	O
O: 表示该有毒有害物质在该部件所有均质材料中的含量均在 SJ/T 11363-2006 标准规定的限量要求以下。						
X: 表示该有毒有害物质至少在该部件的某一均质材料中的含量超出 SJ/T 11363-2006 标准规定的限量要求。(企业可在此处, 根据实际情况对上表中打 "X" 的技术原因进行进一步的说明。)						

Doc. #53-14982 March 23, 2015

LI-200R-SMV-x (x = 2, 5, 15, 50)						
Component Name	Hazardous Substances or Elements					
	Lead (Pb)	Mercury (Hg)	Cadmium (Cd)	Chromium VI Compounds (Cr ⁶⁺)	Polybrominated Biphenyls (PBB)	Polybrominated Diphenyl Ethers (PBDE)
Millivolt Adapter Assembly	X	O	O	O	O	O
Pyranometer Sensor Head Assembly	X	O	O	O	O	O
Base and Cable Assembly	X	O	O	O	O	O
O: this component does not contain this hazardous substance above the maximum concentration values in homogeneous materials specified in the SJ/T 11363-2006 Industry Standard.						
X: this component does contain this hazardous substance above the maximum concentration values in homogeneous materials specified in the SJ/T 11363-2006 Industry Standard (Company can explain the technical reasons for the "X")						
LI-200R-SMV-x (x = 2, 5, 15, 50)						
部件名称	有毒有害物质或元素					
	铅 (Pb)	汞 (Hg)	镉 (Cd)	六价铬 (Cr ⁶⁺)	多溴联苯 (PBB)	多溴二苯醚 (PBDE)
毫伏适配器组件	X	O	O	O	O	O
日照强度计传感器头组件	X	O	O	O	O	O
底座和电缆组件	X	O	O	O	O	O
O: 表示该有毒有害物质在该部件所有均质材料中的含量均在 SJ/T 11363-2006 标准规定的限量要求以下。						
X: 表示该有毒有害物质至少在该部件的某一均质材料中的含量超出 SJ/T 11363-2006 标准规定的限量要求。(企业可在此处, 根据实际情况对上表中打 "X" 的技术原因进行进一步的说明。)						

Doc. #53-15083 March 23, 2015

2420-BL						
Component Name	Hazardous Substances or Elements					
	Lead (Pb)	Mercury (Hg)	Cadmium (Cd)	Chromium VI Compounds (Cr ⁶⁺)	Polybrominated Biphenyls (PBB)	Polybrominated Diphenyl Ethers (PBDE)
Amplifier Bare Lead Assembly	X	O	O	O	O	O
O: this component does not contain this hazardous substance above the maximum concentration values in homogeneous materials specified in the SJ/T 11363-2006 Industry Standard.						
X: this component does contain this hazardous substance above the maximum concentration values in homogeneous materials specified in the SJ/T 11363-2006 Industry Standard (Company can explain the technical reasons for the "X")						
2420-BL						
部件名称	有毒有害物质或元素					
	铅 (Pb)	汞 (Hg)	镉 (Cd)	六价铬 (Cr ⁶⁺)	多溴联苯 (PBB)	多溴二苯醚 (PBDE)
放大器裸导线总成	X	O	O	O	O	O
O: 表示该有毒有害物质在该部件所有均质材料中的含量均在 SJ/T 11363-2006 标准规定的限量要求以下。						
X: 表示该有毒有害物质至少在该部件的某一均质材料中的含量超出 SJ/T 11363-2006 标准规定的限量要求。(企业可在此处, 根据实际情况对上表中打 "X" 的技术原因进行进一步的说明。)						

Doc. #53-14832 March 23, 2015

2420-BNC						
Component Name	Hazardous Substances or Elements					
	Lead (Pb)	Mercury (Hg)	Cadmium (Cd)	Chromium VI Compounds (Cr ⁶⁺)	Polybrominated Biphenyls (PBB)	Polybrominated Diphenyl Ethers (PBDE)
Amplifier BNC Assembly	X	O	O	O	O	O
O: this component does not contain this hazardous substance above the maximum concentration values in homogeneous materials specified in the SJ/T 11363-2006 Industry Standard.						
X: this component does contain this hazardous substance above the maximum concentration values in homogeneous materials specified in the SJ/T 11363-2006 Industry Standard (Company can explain the technical reasons for the "X")						
2420-BNC						
部件名称	有毒有害物质或元素					
	铅 (Pb)	汞 (Hg)	镉 (Cd)	六价铬 (Cr ⁶⁺)	多溴联苯 (PBB)	多溴二苯醚 (PBDE)
放大器BNC大会	X	O	O	O	O	O
O: 表示该有毒有害物质在该部件所有均质材料中的含量均在 SJ/T 11363-2006 标准规定的限量要求以下。						
X: 表示该有毒有害物质至少在该部件的某一均质材料中的含量超出 SJ/T 11363-2006 标准规定的限量要求。(企业可在此处, 根据实际情况对上表中打 "X" 的技术原因进行进一步的说明。)						

Doc. #53-14833 March 23, 2015

Contents

Section 1. General Information

Comparing LI-COR® Radiation Sensors	1-2
Cable Options	1-3
Accessories	1-4
Configurations	1-4

Section 2. Using the LI-200R Pyranometer

Mounting	2-1
Calibration Constants and Multipliers	2-2
Using the LI-200R-BNC Pyranometer	2-3
Using the LI-200R-BL Pyranometer	2-3
Voltage Signal Options	2-5

Section 3. Millivolt Adapters

2220 Millivolt Adapter	3-1
LI-200R-SMV Pyranometer	3-3

Section 4. 2420 Light Sensor Amplifier

2420 Amplifier Gain Settings	4-1
Connecting to a Data Logger	4-4
Differential Wiring	4-5
Single-ended Wiring	4-5
Connecting to a Sensor	4-6
Equation Summary	4-7
Output Voltage	4-7
Ideal Gain	4-7
Voltage Multiplier	4-7
2420 Amplifier Performance Characteristics	4-8

Output	4-8
2420 Amplifier Specifications	4-8

Section 5. Performance Characteristics

Cosine Correction	5-1
Spectral Response	5-3
Calibration	5-5

Section 6. Care and Maintenance

Factory Recalibration	6-1
Removing a Cable	6-2
Sensor Base Cover	6-3
Installing a Cable	6-3
Replacement Parts	6-4

Section 7. Troubleshooting

Appendix A. Specifications

Appendix B. Warranty

Appendix C. Index

Section 1.

General Information

This manual provides basic operating instructions for the LI-200R Pyranometer and its accessories. The LI-200R measures global solar radiation (solar irradiance received on a horizontal surface) with a silicon photodiode mounted under a cosine-corrected acrylic diffuser. The sensor output is a current (μA) signal that is directly proportional to hemispherical solar radiation. A multiplier is used to convert the current signal into units of radiation (W m^{-2}).



Typical applications for the LI-200R include solar energy, meteorology, agriculture, and environmental research.

Important Note: *The LI-200R should only be used to measure unobstructed daylight. Measurements under vegetation, cloud cover, artificial lights, in a greenhouse, or of reflected solar radiation may not be accurate.* The spectral response of the LI-200R does not include the entire solar spectrum (Figure 5-3 on page 5-4). Therefore, it must be used under lighting conditions that are the same as those under which it was calibrated.

Comparing LI-COR® Radiation Sensors

Each LI-COR radiation sensor is optimized for a particular application and measurement type (*Table 1-1* below). LI-192SA and LI-193SA sensors are submersible, but they can also be used in the atmosphere. The LI-191R Line Quantum Sensor is often used within plant canopies. LI-190R, LI-200R, and LI-210R sensors consist of a sensor head attached to a removable base and cable assembly.

Table 1-1. LI-COR radiation sensors.

Sensor	Measurement	Units	Waveband
LI-190R Quantum Sensor	Photosynthetically active radiation (PAR)	$\mu\text{mol s}^{-1} \text{m}^{-2}$	400 to 700 nm
LI-191R Line Quantum Sensor			
LI-192SA Underwater Quantum Sensor			
LI-193SA Underwater Spherical Quantum Sensor			
LI-200R Pyranometer	Global solar radiation	W m^{-2}	400 to 1100 nm
LI-210R Photometric Sensor	Light as perceived by the human eye	Lux or klux	450 to 650 nm



Figure 1-1. LI-COR radiation sensors.

Cable Options

The detachable base and cable assembly provides benefits including:

- Reduced cost of cable repairs
- The ability to replace or recalibrate a light sensor without removing the cable from the mounting structure
- Cable interchangeability with any LI-190R, LI-200R, or LI-210R sensor head

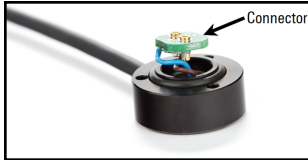

Figure 1-2. Sensor base and cable assembly detached from the sensor head.

The shielded cable leading from the sensor base terminates with either bare wire leads or a weather-resistant, nickel-plated brass BNC connector (*Figure 1-3* below). For sensors with a BNC connector, the body of the connector carries a positive signal and is connected to the shield of the cable, while the center conductor is negative. This arrangement reduces electronic interference.



Figure 1-3. Sensor Terminal Types.

BNC or bare leads (BL) terminal types are available with cable lengths of 2, 5, 15, or 50 meters.

Calibrated LI-190R, LI-200R, or LI-210R sensor heads (without cables) are available for purchase from LI-COR. Sensor heads can replace damaged heads, or be used as spares.

Any base and cable assembly can be used interchangeably with any LI-190R, LI-200R, or LI-210R sensor head.



Accessories

These optional accessories are available for use with the LI-200R Pyranometer:

- **2220 Millivolt Adapter**, 147 Ω resistance (*2220 Millivolt Adapter* on page 3-1)
- **2420 Light Sensor Amplifier** (*2420 Light Sensor Amplifier* on page 4-1)
- **2003S Mounting and Leveling Fixture**. Anodized aluminum with stainless steel leveling screws and a weatherproof spirit level
- **2001S Sensor Base Cover**. Anodized aluminum

Configurations

The LI-200R Pyranometer connects directly to devices that read a current (μA) sensor signal (*Table 1-2* below). *Table 1-3* below lists pyranometer configurations for producing a voltage signal.

Table 1-2. Configurations for a current (μA) signal. Ultimate termination is BNC or bare leads.

Sensor Termination Type...	...connects to...
LI-200R-BNC	<ul style="list-style-type: none"> • LI-1500 Light Sensor Logger • LI-1400 Datalogger • LI-250A Light Meter
LI-200R-BL	<ul style="list-style-type: none"> • Terminal block of the LI-1400 Datalogger • Non-LI-COR devices that read a current (μA) signal

Table 1-3. Configurations for a voltage signal. Ultimate termination is bare leads.

Sensor Termination...	...coupled with...	...connects to...
LI-200R-BNC	2220 mV Adapter (0 to 10 mV output)	Devices that read a voltage signal with good resolution (in the μV range)
LI-200R-SMV Includes a standard output mV adapter with 10 mV output at full scale (part number 2320)		
LI-200R-BL	Precision resistor	
LI-200R-BNC	2420-BNC Amplifier (-2.5 to 5.0 V output)	Devices that read a voltage signal
LI-200R-BL	2420-BL Amplifier (-2.5 to 5.0 V output)	

Section 2.

Using the LI-200R Pyranometer

Mounting

The LI-200R Pyranometer may be hand-held or mounted to an instrument platform. For best results, install your sensor in the 2003S Mounting and Leveling Fixture. Secure the sensor in the fixture by tightening the mounting screws against the sensor base. Level the fixture with the bubble by adjusting the three leveling screws. The 2003S Mounting and Leveling Fixture can be secured to a structure with bolts or screws placed through the three holes in the fixture.

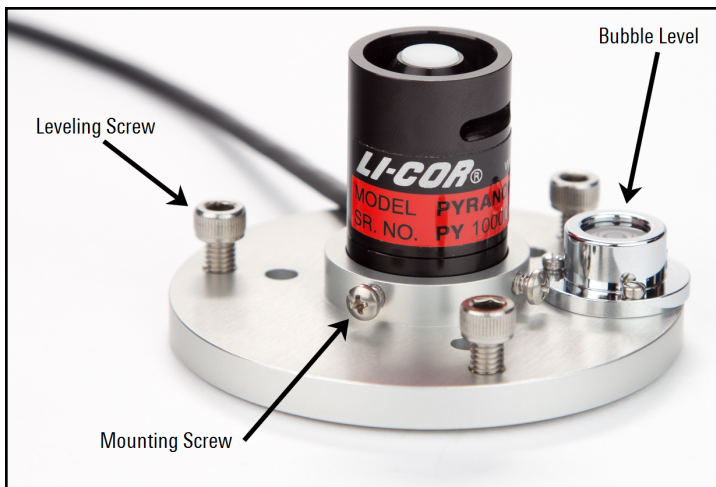

Figure 2-1. LI-200R Pyranometer mounted in the 2003S Mounting and Leveling Fixture.

Secure cables to the instrument platform using cable ties. Be sure there is no strain on the junction where the cable enters the sensor housing, and use a cable tie at any sharp bends in the cable.

Calibration Constants and Multipliers

Each LI-COR radiation sensor is shipped with a certificate of calibration. The certificate is also available at www.licor.com/env/support/. Enter the sensor's serial number in the calibration search box. The calibration constant and multipliers are listed on the certificate in the following order:

Calibration constant

The current signal produced by a sensor is related to radiation intensity with a calibration constant unique to each pyranometer, expressed in units of μA per 1000 W m^{-2} . The calibration constant is used to compute calibration multipliers.

Multiplier for use with LI-COR handheld meters and loggers

LI-COR handheld meters and loggers convert the current (μA) signal into units of radiation (W m^{-2}) by applying this multiplier, expressed in radiation units per current ($\text{W m}^{-2} \mu\text{A}^{-1}$). This multiplier is a negative number.

Multiplier for use with LI-200R-BL (3-wire bare leads)

This multiplier is expressed in radiation units per current ($\text{W m}^{-2} \mu\text{A}^{-1}$) and is a positive number.

Multiplier for use with LI-COR 2220 (147 Ω) Millivolt Adapter

This multiplier is expressed in radiation units per voltage ($\text{W m}^{-2} \text{mV}^{-1}$) and is a negative number.

Multiplier for use with the SMV Pyranometer

The final multiplier listed is $-100.0 \text{ W m}^{-2} \text{mV}^{-1}$. The multiplier is the same for any LI-200R-SMV Pyranometer because the resistance of the included standard output millivolt adapter (part number 2320) is adjusted to each sensor's current output (*LI-200R-SMV Pyranometer* on page 3-3). The LI-200R-SMV replaces the LI-200SL and uses the same millivolt adapter and multiplier.

Using the LI-200R-BNC Pyranometer

Connect the BNC-type cable directly to a BNC input port on an LI-250A Light Meter, LI-1400 Datalogger, or LI-1500 Light Sensor Logger. These devices directly measure the current (μA) signal from the sensor. Enter the sensor's multiplier (see *Multiplier for use with LI-COR handheld meters and loggers* on the previous page) into the device to determine global solar radiation expressed in units of W m^{-2} .

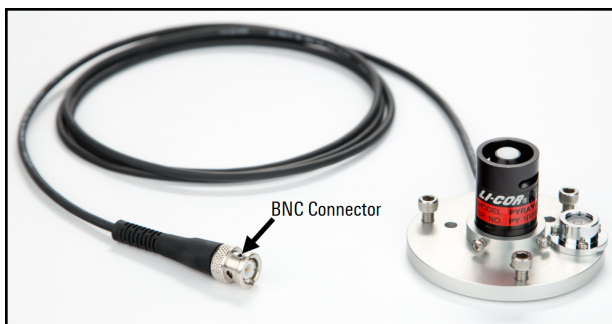

Figure 2-2. LI-200R-BNC Pyranometer.

LI-1500
Light Sensor Logger



BNC Input Ports

Using the LI-200R-BL Pyranometer

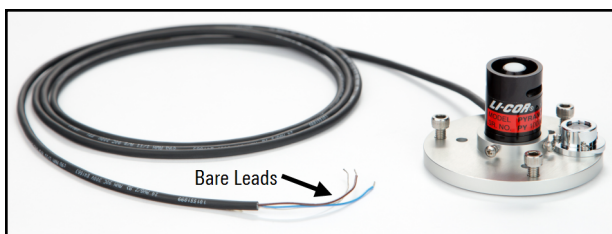
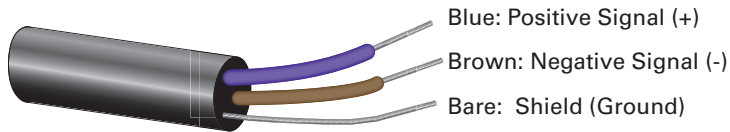

Figure 2-3. LI-200R-BL Pyranometer featuring 3-wire bare leads.

A BL-type sensor cable terminates with bare wire leads. Connect the bare leads to the input terminal block of a device that directly measures a current (μA) signal. The blue wire carries a positive signal and the brown wire is negative. Connecting the bare (shield) wire to ground will reduce noise in the sensor signal.



To log radiation units (W m^{-2}), configure the recording device to multiply the μA signal by the sensor's multiplier (see *Multiplier for use with LI-200R-BL (3-wire bare leads)* on page 2-2) prior to logging the values. If logging the μA sensor signal, apply the multiplier after logging.

The LI-200R-BL can be used with recording devices that require a voltage (mV) signal by adding a precision resistor (see *Voltage Signal Options* on the facing page).

Voltage Signal Options

If the meter or logging device requires a voltage signal, options include:

- **LI-200R-BNC coupled with a 2220 Millivolt Adapter.** The 2220 Millivolt Adapter converts the current (μA) signal from the sensor into a millivolt-level voltage (*Millivolt Adapters* on page 3-1).
- **LI-200R-SMV Pyranometer.** The LI-200R-SMV includes a Standardized Millivolt Adapter (part number 2320) matched to a particular sensor. The serial numbers on the adapter and the sensor must match! The advantage over the 2220 Millivolt Adapter is that the multiplier in your device does not need to be changed for different sensors (*LI-200R-SMV Pyranometer* on page 3-3).
- **LI-200R coupled with a 2420 Light Sensor Amplifier.** The 2420 Amplifier converts the current (μA) signal from the sensor into a voltage (*2420 Light Sensor Amplifier* on page 4-1).
- **LI-200R-BL coupled with a precision resistor.** Connect the resistor across the positive and negative leads of the cable. The recommended resistance is 147Ω , with a maximum output of approximately 10 mV per 1000 W m^{-2} . See *Millivolt Adapters* on page 3-1 for instructions on calculating the multiplier, but use the absolute value of the multiplier.

With a Millivolt Adapter or other resistor, the signal to noise ratio (sensitivity) is lower than with the 2420 Light Sensor Amplifier, but the cost is less and there is no need for a power supply to the adapter.

Caution: Do not attach the sensor to a power source. The sensor is self-powered.

Section 3.

Millivolt Adapters

LI-COR radiation sensors produce a current (μA) output signal that can be converted to a voltage through the use of a resistor. LI-COR makes two types of millivolt adapters for use with our BNC-type radiation sensors. Each adapter includes a precision resistor and a BNC connector that mates with the sensor. Bare leads can be connected to a data logger or other device that reads a voltage signal.

The maximum output of LI-COR radiation sensors in typical conditions is relatively small (microamps of current) and converts into a small voltage. To monitor these sensors with expected accuracy, a data logger needs to have the ability to measure in the microvolt range. To increase sensitivity, make sure the voltage range of the channel is set as close as possible to the full-scale range of the sensor. For example, 0 to 25 mV should cover the range of values expected in a natural sunlight environment.

If the data logger does not have the ability to measure microvolt signals or the ability to set channel voltage ranges down to a 0–25 mV level, another option should be considered, such as the 2420 Light Sensor Amplifier.

2220 Millivolt Adapter

An LI-200R Pyranometer with a BNC-type cable can be used with a millivolt recorder or data logger by connecting a model 2220 Millivolt Adapter. Convert the voltage measured by the data logger into radiation units (W m^{-2}) by applying the appropriate multiplier, given on the

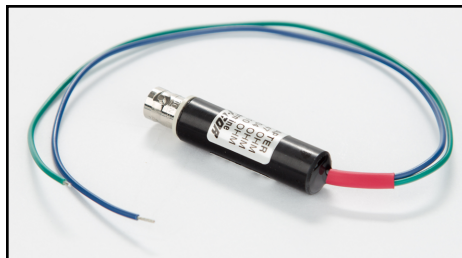

sensor's certificate of calibration (see *Multiplier for use with LI-COR 2220 (147 Ω) Millivolt Adapter* on page 2-2).

The multiplier M for use with a millivolt adapter can also be found by:

$$M = \frac{-1}{G \cdot C} \quad 1$$

The 2220 Millivolt Adapter includes a precision resistor with a fixed resistance of 147 Ω , tolerance of $\pm 0.1\%$, and a fixed gain of $G = 0.147 \text{ mV } \mu\text{A}^{-1}$. The sensor's calibration constant C is found on the certificate of calibration (see *Calibration constant* on page 2-2). The calculated multiplier will be a negative number (because the shield of the coaxial cable of the sensor carries the positive signal) and is expressed in units of $\text{W m}^{-2} \text{ mV}^{-1}$.

Example: Calculate M using $G = 0.147 \text{ mV } \mu\text{A}^{-1}$ and $C = 93.75 \text{ } \mu\text{A per } 1000 \text{ W m}^{-2}$

$$M = \frac{-1}{\left(0.147 \frac{\text{mV}}{\mu\text{A}}\right) \left(\frac{93.75 \mu\text{A}}{1000 \text{ W m}^{-2}}\right)} = -72.56 \text{ W m}^{-2} \text{ mV}^{-1} \quad 2$$

Connecting the 2220 Millivolt Adapter

If the data logger or recorder being used with this millivolt adapter has bipolar capability, connect the positive (green) lead to the common (low) terminal, and connect the negative (blue) lead to signal (high) input. This will help minimize noise.

If the data logger has high, low, and ground terminals, place a jumper wire between the common (low) and ground terminals.

If bipolar signal capability is not available, connect the positive (green) lead to the signal input, and the negative (blue) lead to the common terminal. In this case, use the absolute value of the multiplier.

LI-200R-SMV Pyranometer

The LI-200R-SMV Pyranometer includes a Standard Output Millivolt Adapter (part number 2320) terminating in bare leads. The serial number on the pyranometer head must match the serial number on the adapter because the resistance is adjusted to each sensor's current output. This allows a standardized output of 10 mV per 1000 W m⁻². The multiplier used to convert the voltage measured by the data logger into a light intensity is -100.0 W m⁻² mV⁻¹ (also listed on the sensor's certificate of calibration).

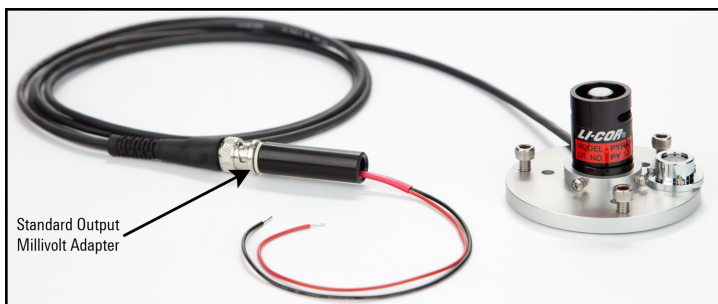

Figure 3-1. LI-200R-SMV Pyranometer.

The advantage of using an LI-200R-SMV (compared to an LI-200R-BNC with a 2220 Millivolt Adapter) is that sensors can be exchanged in the field without the need to enter a unique multiplier in the data logger or recorder.

An LI-200R Pyranometer with a BNC-type connector can be converted to an LI-200R-SMV by attaching a Standard Output Millivolt Adapter (part number 2320) to the BNC connector. The 2320 adapter must be matched to the individual sensor. LI-COR needs the sensor's serial number in order to adjust an adapter to match the sensor.

Connecting the LI-200R-SMV Pyranometer

If your data logger or recorder has bipolar signal capability, connect the positive (red) lead to the common (low) terminal, and connect the negative (black) lead to signal (high) input. This will help minimize noise in the signal.

If the data logger has high, low, and ground terminals, place a jumper wire between the common (low) and ground terminals.

If bipolar signal capability is not available, connect the positive (red) lead to the signal input, and the negative (black) lead to the common terminal. In this case, use the absolute value of the multiplier.

Section 4.

2420 Light Sensor Amplifier

The 2420 Light Sensor Amplifier converts the current (μA) signal from the radiation sensor into a voltage that can be measured by most data loggers and system controllers. The 2420 Amplifier works with both old and new LI-COR radiation sensor designs. Two amplifier models are available:

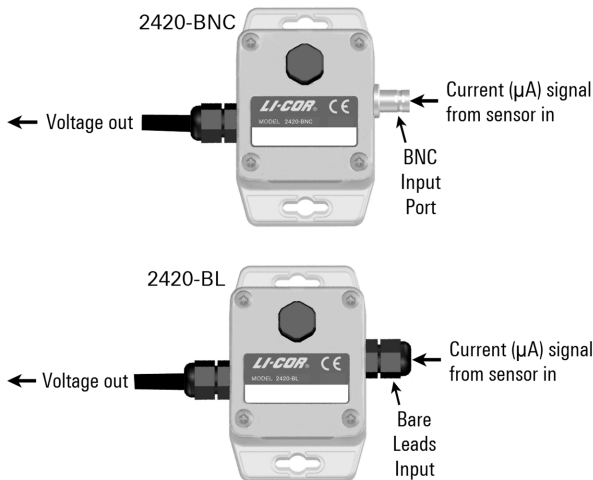

Note: The 2420 Amplifier is weather resistant **with the lid properly attached**, but if it is to be left outdoors for long periods of time, it should be installed in a protective enclosure or sheltered location.

2420 Amplifier Gain Settings

The 2420 Amplifier provides 15 discrete gain settings to accommodate a variety of full-scale light intensities, full-scale voltage ranges, and sensor types. This section

shows how to determine the correct gain settings and multiplier. Gather the following information:

- Calibration constant for your light sensor (C)
- Maximum full-scale radiation intensity to be measured (I_{max})
- Full-scale input voltage of the datalogger (V_{max})

Follow these steps to calculate the amplifier gain setting and voltage multiplier:

- 1 Calculate the ideal amplifier gain (G_{ideal}).

$$G_{ideal} = \frac{V_{max}}{I_{max} \cdot C}$$

Example: Consider a quantum sensor installation with the following parameters:

- Sensor calibration constant: $C = 6.5 \mu\text{A per } 1000 \mu\text{mol m}^{-2} \text{ s}^{-1}$
- Full-scale light intensity: $I_{max} = 2000 \mu\text{mol m}^{-2} \text{ s}^{-1}$
- Datalogger full-scale channel voltage: $V_{max} = 5.0 \text{ V}$

$$G_{ideal} = \frac{5.0 \text{ V}}{\left(2000 \mu\text{mol m}^{-2} \text{ s}^{-1}\right) \left(\frac{6.5 \mu\text{A}}{1000 \mu\text{mol m}^{-2} \text{ s}^{-1}}\right)} = .3846 \text{ V } \mu\text{A}^{-1}$$

- 2 Select the gain setting (G) from . *Gain settings table for the 2420 Amplifier* on the facing page that is less than or equal to the ideal gain from step 1.

Example: The ideal gain computed in step 1 is $G_{ideal} = 0.3846 \text{ V } \mu\text{A}^{-1}$. On the table, the closest actual gain that is less than or equal to this value is $G = 0.375 \text{ V } \mu\text{A}^{-1}$.

- 3 Use a number 2 Phillips screwdriver to remove the amplifier lid. Alternate the four screws, pulling the lid up with the screws as you go so that the screws do not bind with the lid.
- 4 Using a small screwdriver, set the four switches in the center of the circuit board based on the amplifier gain determined in step 2.

Example: The amplifier gain determined in step 2 ($G = 0.375 \text{ V } \mu\text{A}^{-1}$) requires all switches to be in the off position:

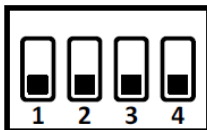

$G = 0.375$
all switches off

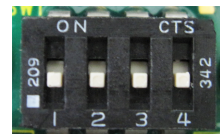
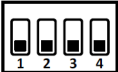
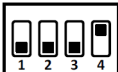









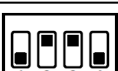

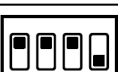



Table 4-1. Gain settings table for the 2420 Amplifier

2420 Gain Settings Table			
DIP Switch	Gain ($V \mu A^{-1}$)	DIP Switch	Gain ($V \mu A^{-1}$)
	$G = 0.375$ (all switches off)		$G = 0.175$
	$G = 0.350$		$G = 0.150$
	$G = 0.325$		$G = 0.125$
	$G = 0.300$		$G = 0.100$
	$G = 0.275$		$G = 0.075$
	$G = 0.250$		$G = 0.050$
	$G = 0.225$		$G = 0.025$
	$G = 0.200$		Do Not Use (all switches on)

- 5 Re-install the lid. Torque the screws to 0.45 Nm (64 oz-in.) if using a torque screwdriver.
- 6 Calculate the voltage multiplier (M). The voltage multiplier is used to convert the voltage measured by the data logger into units of radiation ($W m^{-2}$). The units for M are $\mu mol m^{-2} s^{-1} V^{-1}$.

$$M = \frac{1}{G \cdot C}$$

Example: Calculate M using $G = 0.375 V \mu A^{-1}$ from step 2 and $C = 6.5 \mu A$ per 1000 $\mu mol m^{-2} s^{-1}$ from step 1:

$$M = \frac{1}{\left(0.375 \frac{V}{\mu A}\right) \left(\frac{6.5 \mu A}{1000 \mu mol m^{-2} s^{-1}}\right)} = 410.26 \mu mol m^{-2} s^{-1} V^{-1}$$

Connecting to a Data Logger

Note: The 2420 Amplifier requires a power supply (white wire, +3.8 to 28 VDC), usually from the datalogger. The datalogger should wait a minimum of 0.12 seconds (120 ms) after providing power before reading the output voltage from the amplifier.

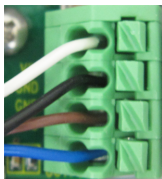

White: +3.8 to 28V power supply input

Black: Power supply ground (\neq)

Brown: Negative (-) amplifier output

Blue: Positive (+) amplifier output

Figure 4-1. Amplifier Output Terminal Block Wiring

The 2420-BNC and 2420-BL Amplifier output wires (included) can be connected to a datalogger in both differential and single-ended configurations, as shown in the following diagrams. The differential configuration can give better noise rejection and lower offset voltages.

Note: Avoid extending the output wire length. The amplifier and data logger should be kept close together to avoid excess voltage drop and the introduction of noise.

Differential Wiring

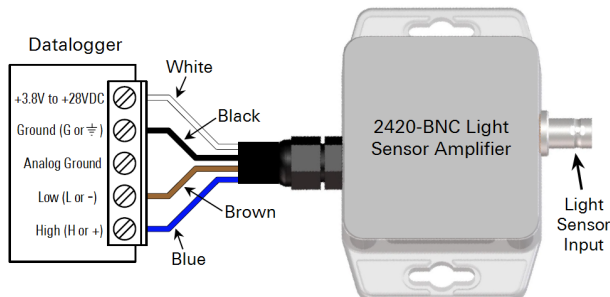

Single-ended Wiring

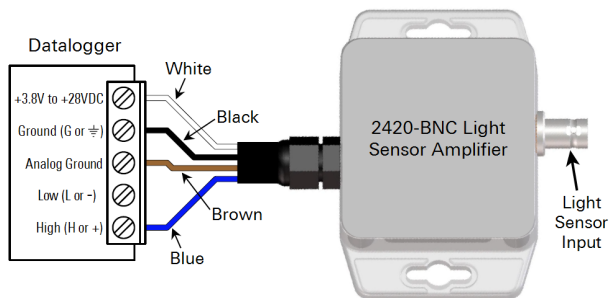

Important Note! In the single-ended configuration, use the following steps to check for ground loops. *This procedure only applies when the 2420 is in the single-ended configuration.*

1. Disconnect the light sensor from the amplifier.
2. Using a multiplier of 1 and an offset of 0 in the datalogger program, monitor the "dark offset" mV measurement from the amplifier.
3. If the dark offset is > 1 mV, try disconnecting either the brown or black lead (but not both) to minimize the offset.
4. If the offset is minimized by removing either the brown or black wire, then move this wire off to the side and insulate it with a piece of electrical tape.
5. Reconnect the light sensor to the amplifier and reset the multiplier and offset in the data logger program.

Connecting to a Sensor

Note: The 2420 Amplifier requires a current (μA) signal from the sensor. It will not work with a millivolt adapter or with a sensor that produces a voltage signal output.

LI-COR radiation sensors come wired with bare leads or a BNC connector.

2420-BNC Light Sensor Amplifier: connects to a BNC type light sensor. Attach the BNC connector to the BNC input port on the Amplifier.

2420-BL Light Sensor Amplifier: connects to a bare lead type sensor with these steps:

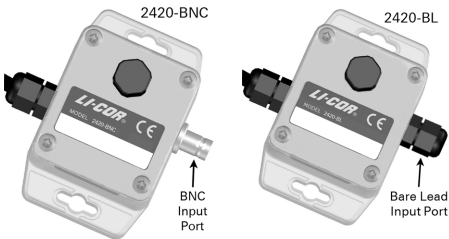

- 1 Use a number 2 Phillips screwdriver to remove the amplifier lid. Alternate the four screws, moving the lid up with the screws so that the screws do not bind with the lid.
- 2 Loosen (but do not remove) the black plastic nut on the input port.
- 3 Feed the sensor cable through the nut and input port far enough that the black shielded portion extends inside the amplifier, then hand tighten the nut.
- 4 Press down the connector's spring release and insert the sensor wires into the terminal block as shown below.

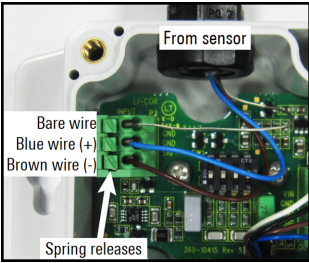

- 5 Re-install the lid. Torque the screws to 0.45 Nm (64 oz-in.) if using a torque screwdriver.

Equation Summary

Output Voltage

The 2420 Light Sensor Amplifier output voltage is computed as:

$$V_{out} = G \cdot i$$

Variable	Units	Description
V_{out}	V	Amplifier output voltage
G	$V \mu A^{-1}$	Amplifier gain setting
i	μA	Light sensor photocurrent signal

Ideal Gain

The ideal gain (G_{ideal}) is the gain needed by the 2420 Amplifier to adjust the full-scale sensor output to the full-scale input voltage of the data logger. The 2420 Amplifier uses 15 discrete gain settings, so the ideal gain must be rounded **down** to the nearest supported gain. Ideal gain is computed as:

$$G_{ideal} = \frac{V_{max}}{I_{max} \cdot C}$$

Variable	Units	Description
G_{ideal}	$V \mu A^{-1}$	Ideal amplifier gain
V_{max}	V	Data logger full-scale input voltage
I_{max}	$W m^{-2}$	Pyranometer full-scale light
C	μA per 1000 $W m^{-2}$	Pyranometer calibration coefficient

Voltage Multiplier

The voltage multiplier M converts the voltage measured by the data logger into a light intensity. The multiplier is found by:

$$M = \frac{1}{G \cdot C}$$

Variable	Units	Description
M	$W m^{-2} V^{-1}$	Pyranometer voltage multiplier
G	$V \mu A^{-1}$	Amplifier gain setting
C	μA per 1000 $W m^{-2}$	Pyranometer calibration coefficient

2420 Amplifier Performance Characteristics

Output

The 2420 Amplifier generates an output signal up to 5.0 V and down to -2.5 V over the entire input supply voltage range (+ 3.8 to 28 VDC). The output is linear with the current signal provided by the light sensor with an offset of $\pm < 10 \mu\text{V}$, meaning that 0 μA of input current yields a 0 V $\pm < 10 \mu\text{V}$ output voltage.

Note: The 2420 Amplifier is capable of driving a resistive load of 10 k Ω or greater. Most datalogger voltage inputs have an input impedance (resistance) much higher than 10 k Ω , satisfying the output loading requirements of the 2420. Loading the output with a resistance less than 10 k Ω may cause erroneous readings.

2420 Amplifier Specifications

2420 Light Sensor Amplifier Specifications	
Power Requirements:	+3.8 to 28 V (1 mA over full range)
Operating Temperature Range:	-40 °C to 50 °C
Turn-on Time:	120 ms
Amplifier Output:	-2.5 to 5.0 V
Output Offset Voltage:	-10 to 10 μV
Amplifier Gain Range:	0.025 to 0.375 V μA^{-1}
Amplifier Gain Accuracy:	$\pm 0.1\%$ typical ($\pm 0.15\%$ max) of gain setting
Amplifier Output Noise:	0.5 μV rms (0.375 V μA^{-1} Gain, 0.1 to 10 Hz Bandwidth)
Amplifier Output Loading:	$\geq 10 \text{ k}\Omega$

Section 5.

Performance Characteristics

The amount of radiation incident on a given flat (not necessarily level) surface area varies with the angle of incidence. Lambert's cosine law says that the radiant intensity observed from an ideal diffusely reflecting surface is directly proportional to the cosine of the angle of incidence.

When radiation strikes a given surface area at a greater angle of incidence, less radiation is received on that surface (see *Figure 5-2* on the next page). For instance, when radiation strikes a given unit area at a 60° angle of incidence, half as much is received compared to a 0° angle of incidence. The same amount of radiation is spread over more surface area at a 60° angle of incidence.

Cosine Correction

A cosine-corrected sensor follows Lambert's cosine law and provides the most accurate measurements of radiation on a flat surface from all angles. Cosine correction ensures accurate measurements under various conditions such as low light levels and low solar elevation angles.

The LI-200R is fully cosine-corrected, with sensitivity to light nearly equal at all angles of incidence to about 82° angle of incidence (*Figure 5-1* on the next page). Errors are typically less than $\pm 5\%$ for angles less than 82° from the normal axis. At 90°, a perfect cosine response would be zero, and any error at that angle is infinite.

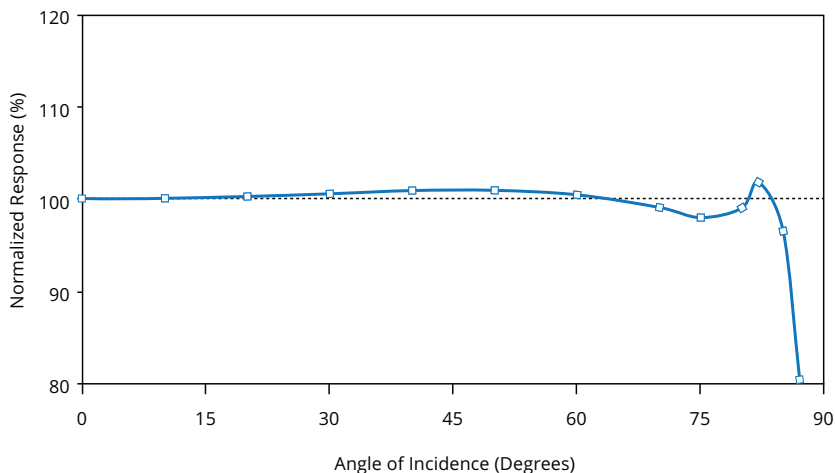

Figure 5-1. Typical cosine response of the LI-200R Pyranometer.

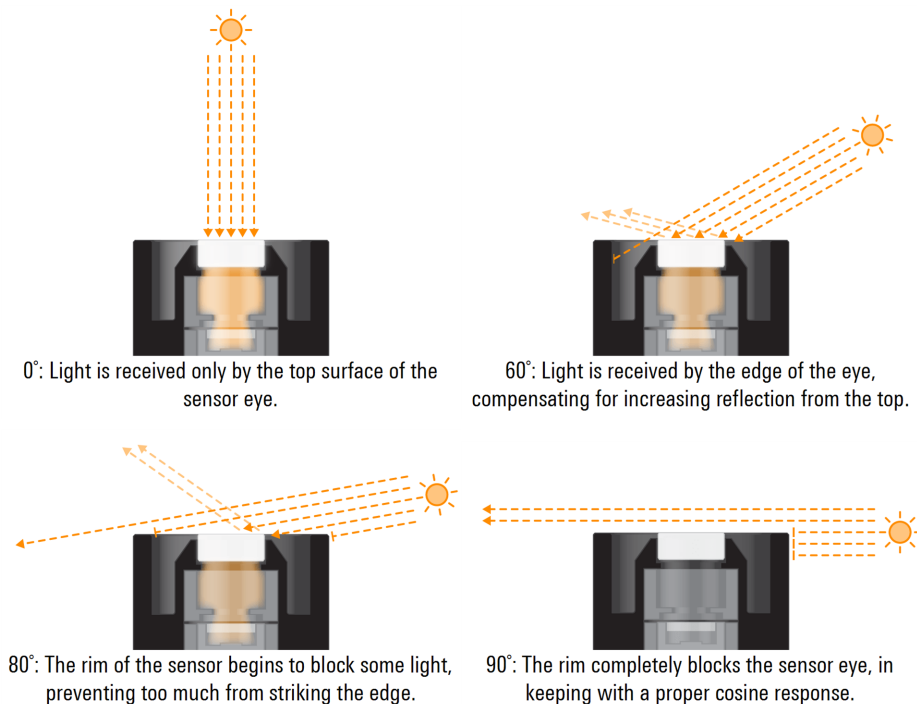

Figure 5-2. LI-COR sensor creating the proper cosine response at various angles of incidence.

Figure 5-2 on the previous page shows how the design of the sensor creates the proper cosine response. Radiation is received by an acrylic disc called a diffuser, or eye. When radiation strikes with a greater angle of incidence, more is received by the edge of the eye. This compensates for increasing reflection from top surface as the angle of incidence grows larger. Beyond an angle of about 80°, the rim of the sensor begins to block some light in order to maintain the correct response as more radiation is received by the edge of the eye. At a 90° angle of incidence, the rim completely blocks the eye, in keeping with a proper cosine response.

Spectral Response

The spectral response of the LI-200R is not equal to the ideal (equal sensitivity from 280 to 2800 nm), but the instrument provides a good measurement of solar radiation when it is used to measure unobstructed daylight.

Changes in the spectral distribution of incident light, coupled with the non-uniform response of the sensor, can lead to measurement errors. Hull¹ shows that in the visible spectrum (400 to 700 nm), the spectral distribution of sun plus sky radiation on a horizontal plane is remarkably constant, even when clear and overcast skies are compared. Gates², however, observed that the spectral distribution of solar radiation in the near-infrared (\approx 700 to 1400 nm), where water vapor absorption takes place, differs on cloudy and clear days. Radiation measurements at low solar elevation angles can show significant error because of atmospheric absorption. This is a small part of the daily total so that observed errors have a negligible effect on daily integrations.

¹Hull, J. N. 1954. Spectral distribution of radiation from sun and sky. Transactions of the Illuminating Engineering Society, London, 19:21-28.

²Gates, D. M. 1965. Radiant energy, its receipt and disposal. Meteorology Monographs, 6:1-26.

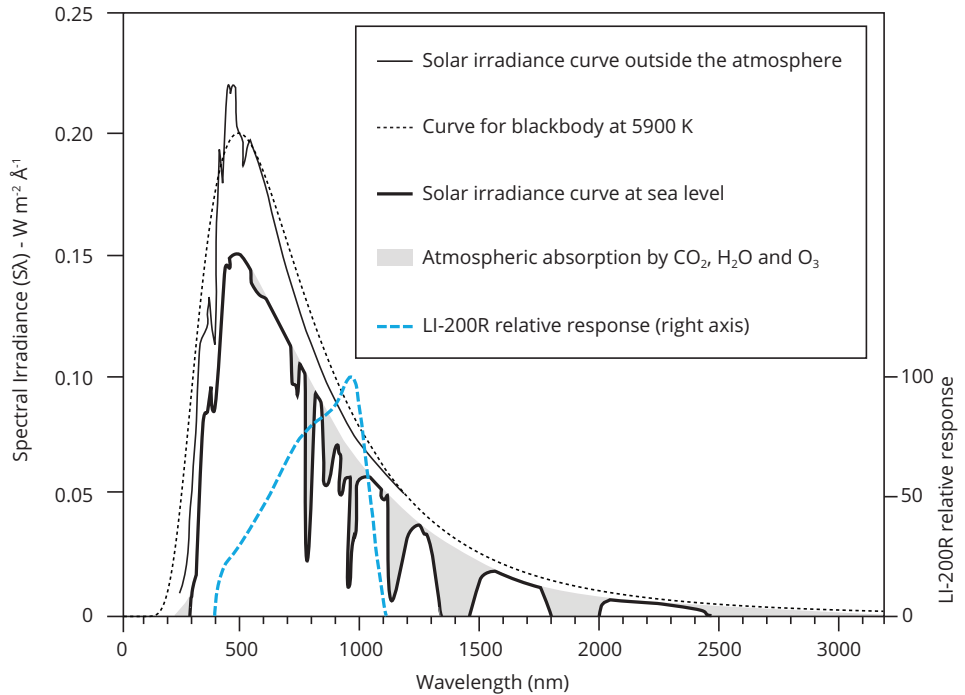

Figure 5-3. Spectral response of the LI-200R Pyranometer along with the energy distribution in the solar spectrum¹.

The area under the spectral irradiance curve of the source is directly proportional to the energy received by a horizontal surface. Under typical conditions, energy received on a completely overcast day has been estimated to be near 11% of that received on a clear day. When both spectral distributions are weighted according to a typical response curve of a silicon photodiode, the response on an overcast day is 12.6%. Therefore, errors due to the spectral response of the photodiode, induced under different sky conditions, will be small. Field tests of Federer and Tanner², and Kerr, Thurtell and Tanner³ confirm this conclusion.

¹Kondratev, K. Ya. 1969. Direct Solar Radiation. In: Radiation in the atmosphere. Academic Press, New York, London.

²Federer, C. A, and C. B. Tanner. 1965. A simple integrating pyranometer for measuring daily solar radiation. *Journal of Geophysical Research*, 70:2301-2306.

³Kerr, J. P., G. W. Thurtell, and C. B. Tanner. 1967. An integrating pyranometer for climatological observer stations and mesoscale networks. *Journal of Applied Meteorology*, 6: 668-694.

Calibration

Each LI-COR radiation sensor is fully calibrated at the factory, and no user calibration is needed. Acquire the calibration for your sensor by entering the serial number at www.licor.com/env/support/. The recommended recalibration interval is every 2 years. Return your sensor to LI-COR for recalibration (*Factory Recalibration* on page 6-1).

Each LI-200R Pyranometer is calibrated against an Eppley Precision Spectral Pyranometer under natural daylight conditions in units of W m^{-2} . Instantaneous paired sensor and reference readings are taken every minute throughout the day for several days. Manual and statistical methods are used to select data from which the calibration constant is derived. Under most natural daylight conditions, the uncertainty of calibration is $\pm 3\%$ typical; $\pm 5\%$ maximum.

Important Note: *The LI-200R should only be used to measure unobstructed daylight. Measurements under vegetation, cloud cover, artificial lights, in a greenhouse, or of reflected solar radiation may not be accurate.* The spectral response of the LI-200R does not include the entire solar spectrum (*Figure 5-3* on the previous page). Therefore, it must be used under lighting conditions that are the same as those under which it was calibrated.

Section 6.

Care and Maintenance

For best performance and longevity, treat the sensor carefully. The protective cap that came with the sensor can be used later when shipping the sensor for factory recalibration.

The vertical edge of the acrylic diffuser must be clean to maintain calibration and correct cosine response. Use warm water and a soft, lint-free towel or cotton-tipped swab to remove dust and other soluble deposits. If needed, use a mild detergent to clean the sensor. Use a solution of vinegar and water for stubborn hard water deposits or salt buildup.



Figure 6-1. LI-200R Pyranometer

Important! Refrain from applying pressure to the diffuser when cleaning the sensor. Scratches on the surface of the diffuser will degrade the cosine performance of the sensor.

The sensor head may be disconnected from the sensor base (*Figure 6-1* above), but do not attempt to disassemble the sensor head. Doing so will alter the sensor's calibration, void the sensor's warranty, and potentially provide entry points for water, which will damage the sensor.

Factory Recalibration

Each sensor is fully calibrated at the factory. The recommended recalibration interval is every 2 years.

Note: A sensor's certificate of calibration indicates the last date of calibration. You can acquire the certificate of calibration for your sensor by entering the sensor serial number at www.licor.com/env/support/.

Return your sensor to LI-COR for recalibration. If possible, replace the protective cap that came with the sensor. Ship the sensor head attached to the base and cable assembly when possible. For tower installations, solar arrays, or other cases where it would be better to leave the cable behind, the sensor head may be removed from the base and cable assembly for shipment.

For uninterrupted data collection, you have the option of purchasing sensor heads without cables. These calibrated sensor heads can be used as spares.

Note: Pyranometer recalibration is only possible from the beginning of March to the end of September because of the need for sufficient daylight.

Removing a Cable

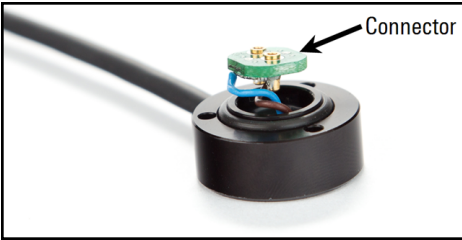

Figure 6-2. Sensor base and cable assembly with sensor head removed.

- 1 Remove the sensor from the mounting and leveling fixture to gain access to the machine screws on the bottom of the sensor base.
- 2 Remove the three screws from the bottom of the sensor base with a number 1 Phillips screwdriver.
- 3 Pull the sensor head away from the base until the two-pin female connector separates from the base pins. Pull the two components straight apart without twisting.
- 4 If the sensor base will be left exposed, install a Sensor Base Cover (*Sensor Base Cover* on the facing page).

Any cable can be used with any sensor head without altering the calibration. Cables are interchangeable between the LI-190R, LI-200R, and LI-210R sensors.

Sensor Base Cover

When a sensor base must be left behind while the head is being factory recalibrated, protect it by attaching a 2001S Sensor Base Cover, available from LI-COR. Attach using the same screws that held the sensor head to the base.



Figure 6-3. Sensor Base Cover installed on the sensor base in place of the sensor head.

Installing a Cable

- 1** Place the protective cap (shipped with the sensor) on the sensor head or use another method to protect the acrylic diffuser on top of the sensor head.
- 2** Turn the sensor head upside down and check the pins to ensure they are not bent. Inspect the o-ring in the base and replace if it is damaged.
- 3** Press the female connector firmly onto the pins of the light sensor head using your finger or a small flat-blade screwdriver. The two-pin connector is polarized so that it can only be attached in one orientation.

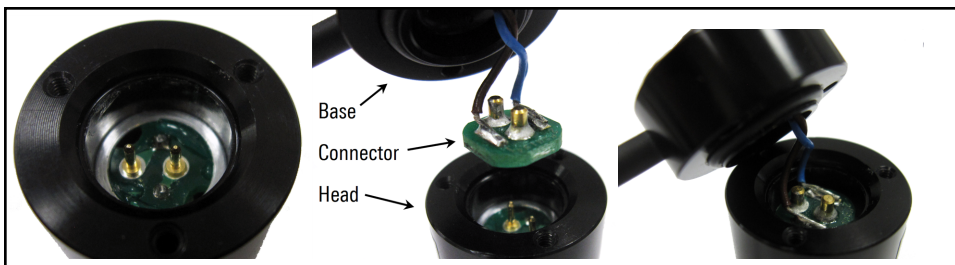

- 4** Orient the light sensor and base so the mounting holes align and insert the three machine screws through the light sensor base and into the sensor head.
- 5** Tighten the screws with a number 1 Phillips screwdriver. If you are using a torque screwdriver, tighten the screws to 0.41 Nm (58 oz-in).

Replacement Parts

The following components are available individually.

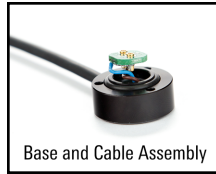

Base and Cable Assemblies:

- BNC-2: 2-meter cable with BNC terminal
- BNC-5: 5-meter cable with BNC terminal
- BNC-15: 15-meter cable with BNC terminal
- BNC-50: 50-meter cable with BNC terminal
- BL-2: 2-meter cable with bare leads
- BL-5: 5-meter cable with bare leads
- BL-15: 15-meter cable with bare leads
- BL-50: 50-meter cable with bare leads



200R: Calibrated Pyranometer Head

Replace a damaged base and cable assembly or change the terminal type and / or cable length of a sensor by purchasing a new base and cable assembly from LI-COR and installing it onto the sensor head.

Calibrated LI-190R, LI-200R, or LI-210R sensor heads (without cables) are available for purchase from LI-COR. Sensor heads can replace damaged heads, or be used as spares.

Any base and cable assembly can be used interchangeably with any LI-190R, LI-200R, or LI-210R sensor head.



- **Flat head Phillips machine screw**, 2-56 threads, 1/2" long, 82° countersink, stainless steel (for securing the sensor base to the sensor head), LI-COR part number 122-12774. Three screws are required for each sensor.
- **O-ring AS-014 Viton75** (for the sensor base), LI-COR part number 192-14878.

Section 7.

Troubleshooting

Sensor readings are negative (-) or zero:

- Check for proper wiring of the LI-200R-BL (see *Multiplier for use with LI-200R-BL (3-wire bare leads)* on page 2-2), 2220 Millivolt Adapter (*Connecting the 2220 Millivolt Adapter* on page 3-2), or LI-200R-SMV Pyranometer (*LI-200R-SMV Pyranometer* on page 3-3).
- Make sure the proper sign was used on the multiplier entered into the LI-1500, LI-1400, or LI-250A, or other recording device (*Calibration Constants and Multipliers* on page 2-2). If the number is entered without the negative sign, readings will be zero in the LI-1500 and negative in the LI-1400 and LI-250A.

Sensor readings are incorrect:

- Make sure the meter or logger is properly configured, including entering the sensor's correct calibration multiplier. Note that multipliers are different from the calibration constant, and there are different multipliers for use with millivolt adapters (see *Calibration Constants and Multipliers* on page 2-2).
- Check the sensor's last calibration. Certificates of calibration are available at: www.licor.com/env/support/. Enter the sensor's serial number in the calibration data search box. Certificates include multipliers and the sensor's last calibration date. LI-COR recommends factory recalibration for radiation sensors every two years (*Factory Recalibration* on page 6-1).
- Check for loose cable connections. Moisture on connections can also cause erroneous readings.
- Check the sensor cable for damage, including nicks, cuts, or sharp bends.
- Contact LI-COR technical support (envsupport@licor.com) if you are unable to resolve the issue.

Appendix A.

Specifications

Absolute Calibration: Calibrated against an Eppley Precision Spectral Pyranometer (PSP) under natural daylight conditions. Absolute uncertainty under these conditions is $\pm 3\%$ typical; $\pm 5\%$ maximum

Sensitivity: Typically $75 \mu\text{A}$ per 1000 W m^{-2}

Linearity: Maximum deviation of 1% up to 3000 W m^{-2}

Response Time: Less than $1 \mu\text{s}$ (2 m cable terminated into a 147Ω load)

Temperature Dependence: $\pm 0.15\%$ per $^{\circ}\text{C}$ maximum

Cosine Correction: Cosine corrected up to 82° angle of incidence

Azimuth: $< \pm 1\%$ error over 360° at 45° elevation

Tilt: No error induced from orientation

Operating Temperature Range: -40°C to 65°C

Detector: High stability silicon photovoltaic detector (blue enhanced)

Sensor Housing: Weatherproof anodized aluminum case with acrylic diffuser and stainless steel hardware; O-ring seal on the sensor base

Size: 2.36 cm Diameter x 3.63 cm (0.93" x 1.43")

Weight: 24 g head; 60 g base and cable (2 m) with screws

Cable Length: 2 m, 5 m, 15 m, 50 m (6.5', 16.4', 49.2', 164')

2420 BL Dimensions

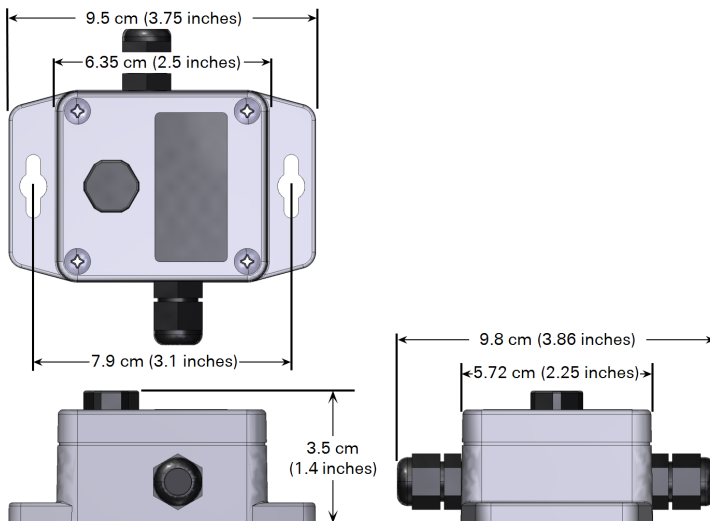

2420 BNC Dimensions

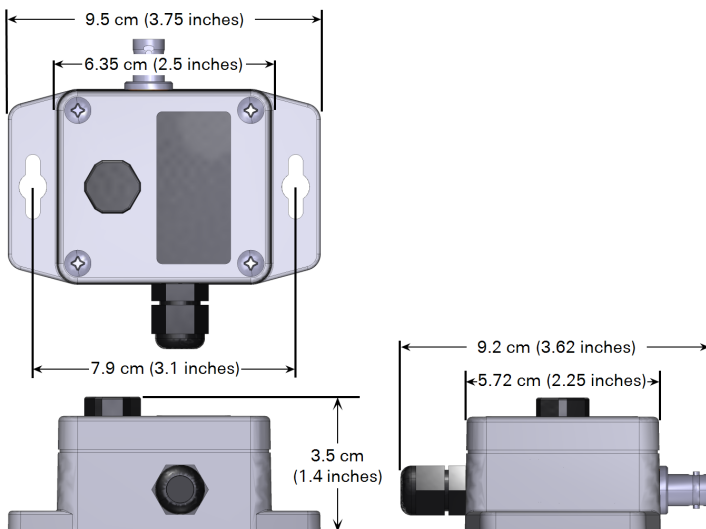

Appendix B.

Warranty

Each LI-COR, Inc. instrument is warranted by LI-COR, Inc. to be free from defects in material and workmanship; however, LI-COR, Inc.'s sole obligation under this warranty shall be to repair or replace any part of the instrument which LI-COR, Inc.'s examination discloses to have been defective in material or workmanship without charge and only under the following conditions, which are:

- 1** The defects are called to the attention of LI-COR, Inc. in Lincoln, Nebraska, in writing within one year after the shipping date of the instrument.
 - 2** The instrument has not been maintained, repaired or altered by anyone who was not approved by LI-COR, Inc.
 - 3** The instrument was used in the normal, proper and ordinary manner and has not been abused, altered, misused, neglected, involved in an accident or damaged by act of God or other casualty.
 - 4** The purchaser, whether it is a DISTRIBUTOR or direct customer of LI-COR or a DISTRIBUTOR'S customer, packs and ships or delivers the instrument to LI-COR, Inc. at LI-COR Inc.'s factory in Lincoln, Nebraska, U.S.A. within 30 days after LI-COR, Inc. has received written notice of the defect. Unless other arrangements have been made in writing, transportation to LI-COR, Inc. (by air unless otherwise authorized by LI-COR, Inc.) is at customer expense.
 - 5** No-charge repair parts may be sent at LI-COR, Inc.'s sole discretion to the purchaser for installation by purchaser.
 - 6** LI-COR, Inc.'s liability is limited to repair or replace any part of the instrument without charge if LI-COR, Inc.'s examination disclosed that part to have been defective in material or workmanship.
- There are no warranties, express or implied, including but not limited to any implied warranty of merchantability of fitness for a particular purpose on**

underwater cables or on expendables such as batteries, lamps, thermocouples, and calibrations.

Other than the obligation of LI-COR, Inc. expressly set forth herein, LI-COR, Inc. disclaims all warranties of merchantability or fitness for a particular purpose. The foregoing constitutes LI-COR, Inc.'s sole obligation and liability with respect to damages resulting from the use or performance of the instrument and in no event shall LI-COR, Inc. or its representatives be liable for damages beyond the price paid for the instrument, or for direct, incidental or consequential damages.

The laws of some locations may not allow the exclusion or limitation on implied warranties or on incidental or consequential damaged, so the limitations herein may not apply directly. This warranty gives you specific legal rights, and you may already have other rights which vary from state to state. All warranties that apply, whether included by this contract or by law, are limited to the time period of this warranty which is a twelve-month period commencing from the date the instrument is shipped to a user who is a customer or eighteen months from the date of shipment to LI-COR, Inc.'s authorized distributor, whichever is earlier.

This warranty supersedes all warranties for products purchased prior to June 1, 1984, unless this warranty is later superseded. To the extent not superseded by the terms of any extended warranty, the terms and conditions of LI-COR's Warranty still apply.

DISTRIBUTOR or the DISTRIBUTOR's customers may ship the instruments directly to LI-COR if they are unable to repair the instrument themselves even though the DISTRIBUTOR has been approved for making such repairs and has agreed with the customer to make such repairs as covered by this limited warranty.

Further information concerning this warranty may be obtained by writing or telephoning Warranty manager at LI-COR, Inc.

Appendix C.

Index

2

- 2001S Sensor Base Cover, 6-3
- 2003S Mounting and Leveling Fixture, 2-1
- 2220 Millivolt Adapter, 3-1
- 2320 Standard Output Millivolt Adapter, 3-3
- 2420 Light Sensor Amplifier, 4-1
 - performance characteristics, 4-8
 - specifications, 4-8

A

- Accessories, 1-4
- Amplifier, 4-1

B

- Bare Leads, 1-3, 2-4
- Base and Cable Assembly, 1-3
 - installing, 6-3, 6-3
 - removing, 6-2
- Base Cover, 6-3
- BNC connector, 1-3

C

- Cable Terminals, 1-3
- Cables, 1-3
 - installing, 6-3, 6-3
 - removing, 6-2
 - securing, 2-1

Calibration

- certificate, 2-2
- constants, 2-2
- factory, 5-5
 - multipliers, 2-2, 2-4
- Certificate of Calibration, 2-2
- Cleaning, 6-1
- Comparing Sensors, 1-2
- Configurations
 - for a current signal, 1-4
 - for a voltage signal, 1-4
- Cosine Response, 5-1

F

- Factory Calibration, 5-5
- Flying Leads, 1-3, 2-4

G

- Gain Settings Table, 4-3
- Gain Settings for the 2420 Amplifier, 4-1
- Global Solar Radiation, 1-1

H

- Heads, Sensor, 6-4

I

- Installing Sensors, 2-1
- Installing the Base and Cable Assembly, 6-3, 6-3

Irradiance, 1-1

L

Leveling Sensors, 2-1
LI-1400 Datalogger, 2-3
LI-1500 Light Sensor Logger, 2-3
LI-190R Quantum Sensor, 1-2
LI-191R Line Quantum Sensor, 1-2
LI-200R-BL Pyranometer, 2-3
LI-200R-BNC Pyranometer, 2-3, 2-3
LI-200R-SMV, 3-3
LI-200R Pyranometer, 1-2
LI-210R Photometric Sensor, 1-2
LI-250A Light Meter, 2-3
Light Meter, LI-250A, 2-3
Light Sensor
 base/cable, 1-3
 specifications, 7
Light Sensor Amplifier, 4-1
Light Sensors
 comparing, 1-2
 mounting, 2-1
Line Quantum Sensor, 1-2
Logger Compatibility, 1-4
Loggers
 LI-1500 and LI-1400, 2-3

M

Meter
 LI-250A, 2-3
Meter Compatibility, 1-4
Millivolt Adapters, 3-1
 2220 Millivolt Adapter, 3-1
 2320 Standard Output, 3-3
Mounting and Levelling Fixture, 2-1
Mounting Sensors, 2-1
Multipliers, 2-3
 for handheld meters, 2-2
 for the 2220 Millivolt Adapter, 2-2
 for the LI-200R-SMV, 2-2, 3-3
 with 3-wire bare leads, 2-2

P

Photometric Sensor, 1-2
Power Supply for the 2420 Amplifier, 4-4
Pyranometer, 1-2

Q

Quantum Sensor, 1-2

R

Radiation, 1-1
Removing the Base and Cable, 6-2
Replacement parts, 6-4

S

Sensor Base Cover, 6-3
Sensor Heads, 6-4
Solar Radiation, 1-1
Specifications, 7
 2420 light sensor amplifier, 4-8
Spectral Response, 5-3
Submersible Quantum Sensors, 1-2

T

Termination Types, 1-4

V

Voltage Signal Options, 2-5

Global Headquarters

LI-COR Biosciences

4647 Superior Street
Lincoln, Nebraska 68504
Phone: +1-402-467-3576
Toll free: 800-447-3576
Fax: +1-402-467-2819
envsales@licor.com
envsupport@licor.com
www.licor.com/env

Regional Offices

LI-COR GmbH, Germany

*Serving Andorra, Albania, Cyprus, Estonia, France, Germany,
Iceland, Latvia, Lithuania, Liechtenstein, Malta, Moldova,
Monaco, San Marino, Ukraine, and Vatican City.*

LI-COR Biosciences GmbH
Siemensstrasse 25A
61352 Bad Homburg
Germany
Phone: +49 (0) 6172 17 17 771
Fax: +49 (0) 6172 17 17 799
envsales-gmbh@licor.com
envsupport-gmbh@licor.com

LI-COR Ltd., United Kingdom

Serving Denmark, Finland, Ireland, Norway, Sweden, and UK.

LI-COR Biosciences UK Ltd.
St. John's Innovation Centre
Cowley Road
Cambridge
CB4 0WS
United Kingdom
Phone: +44 (0) 1223 422102
Fax: +44 (0) 1223 422105
envsales-UK@licor.com
envsupport-UK@licor.com

LI-COR Distributor Network:

www.licor.com/env/distributors

12/16 984-15210

LI-COR[®]